



SERVING THE FOOD INDUSTRY SINCE 1951

# AURORA 47" REFRIGERATED PREP TABLE WITH 2 DOORS - 357 L CAPACITY

Item: 59046 Model: PT-CN-1194E-HC

## MAIN FEATURES

- ▶ Durable and spacious
- ▶ High quality stainless steel 304
- ▶ CFC free refrigerant and foam
- ▶ Digital temperature controller and LCD display (Carel)
- ▶ Ventilated, automatic defrosting and evaporation of condensation water
- ▶ Adjustable heavy-duty PVC coated shelves
- ▶ Round interior corners for easy cleaning
- ▶ Self-closing doors fitted and durable door lock
- ▶ Castor with brake

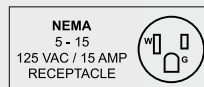

Authorized Dealer

# AURORA 47" REFRIGERATED PREP TABLE



## TECHNICAL DRAWINGS & DIMENSIONS

\*measurements in diagrams are in mm

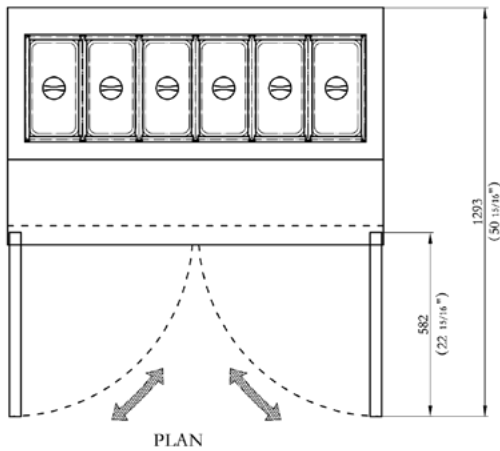
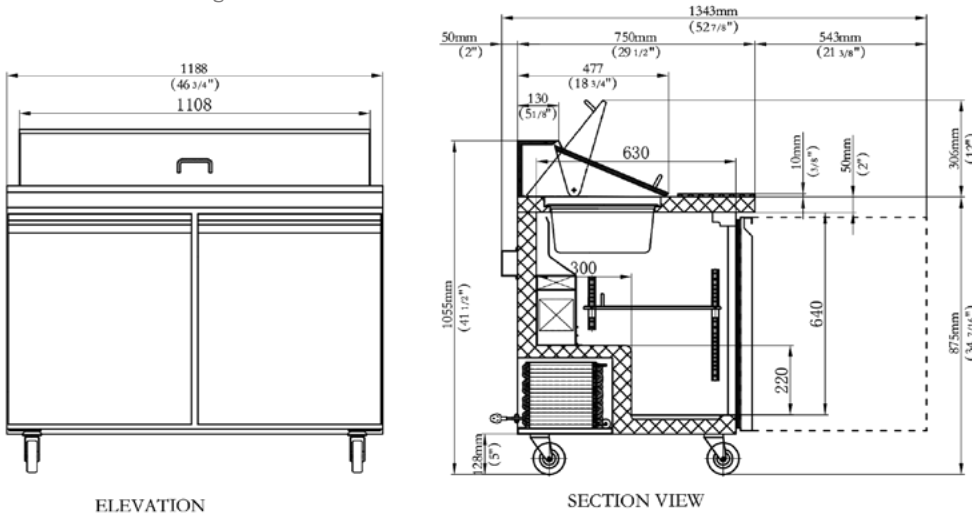

## TECHNICAL SPECIFICATIONS

Aurora 47" Refrigerated Prep Table with 12.6 cu.ft / 357 L capacity	
Item Number	59046
Model	PT-CN-1194E-HC
Net volume	12.6 cu. ft / 357 L
Temperature Range	33°F - 40°F 0.5°C - 4.4°C
Refrigerant	R290
Electrical	110V / 60Hz / 1Ph
Power	408W / 0.55HP
Current	4.08 A
Isolation Material	Cyclopentane
Cooling System	Ventilated
Defrosting	Automatic
Number of Door	2
Number of Shelves	2
Number of Inserts	12 x 1/6 pans or 6 x 1/3 pans
Included Inserts	12 x 1/6 Polycarbonate pans
Shelf Material	Plastic Coated
Shelf Loading Capacity (Per PC)	88 lbs / 40 kg
Exterior Dimensions (WDH)	46.8" x 29.5" x 41.5" 1188 x 750 x 1055 mm
Interior Dimensions (WDH)	43" x 19.8" x 23.5" 1091 x 504 x 597 mm
Net Weight	254 lbs / 115 kg
Gross Weight	348.3 lbs / 158 kg

This equipment is intended for indoor environment using where

ambient temperature do not exceed **24°C / 75°F** & **55%** relative humidity

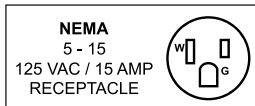

## OMCAN INC.

Telephone: 1-800-465-0234  
 Fax: (905) 607-0234  
 Email: sales@omcan.com  
 Website: www.omcan.com

Follow us to keep up to date with the latest news and offers





SERVING THE FOOD INDUSTRY SINCE 1951

# AURORA 61" MEGA REFRIGERATED PREP TABLE WITH 2 DOORS 469L CAPACITY

Item: 59051 Model: PT-CN-1537E-HC



## MAIN FEATURES

- ▶ Durable and spacious
- ▶ High quality stainless steel 304
- ▶ CFC free refrigerant and foam
- ▶ Digital temperature controller and LCD display (Carel)
- ▶ Ventilated, automatic defrosting and evaporation of condensation water
- ▶ Adjustable heavy-duty PVC coated shelves
- ▶ Round interior corners for easy cleaning
- ▶ Self-closing doors fitted and durable door lock
- ▶ Castor with brake

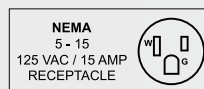

Authorized Dealer

# AURORA 61" MEGA REFRIGERATED PREP TABLE



## TECHNICAL DRAWINGS & DIMENSIONS

\*measurements in diagrams are in mm

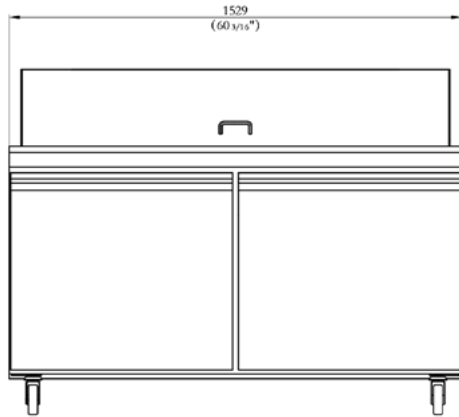

ELEVATION

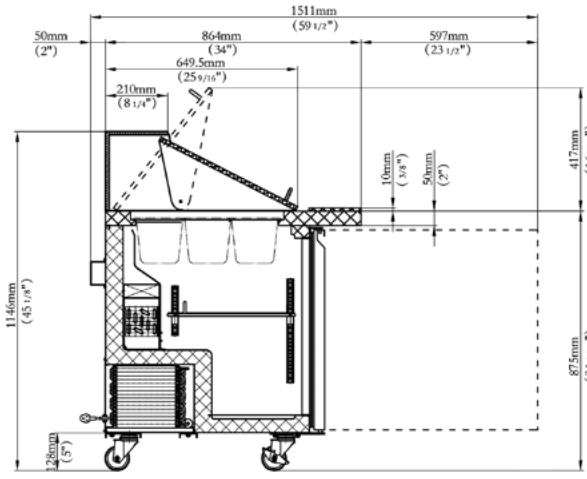

SECTION VIEW

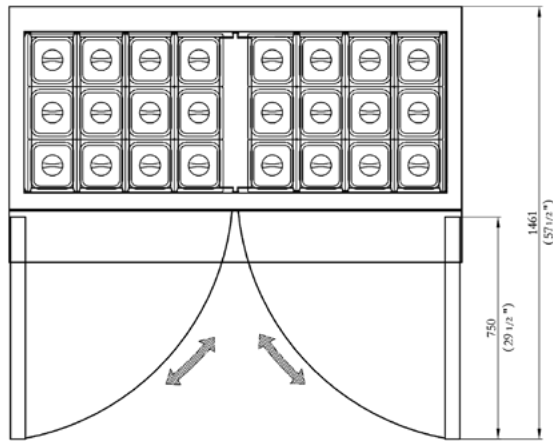

PLAN

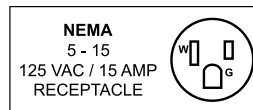

This equipment is intended for indoor environment using where ambient temperature do not exceed **24°C / 75°F** & **55% relative humidity**

### Aurora 61" Mega Refrigerated Prep Table with 16.6 cu.ft / 469 L Capacity

Item Number	59051	Defrosting	Automatic
Model	PT-CN-1537E-HC	Number of Door	2
Net volume	16.6 cu. ft / 469 L	Number of Inserts	24 x 1/6 pans
Temperature Range	33°F - 40°F / 0.5°C - 4.4°C	Number of Shelves	2
Refrigerant	R290	Shelf Material	Plastic Coated
Electrical	115V / 60Hz / 1Ph	Shelf Loading Capacity	88 lbs / 40 kg
Power	504 W	Exterior Dimensions (WDH)	60.2" x 34" x 54.1" / 1529 x 864 x 1146 mm
Current	5.04 A	Interior Dimensions (WDH)	43" x 19.8" x 23.5" / 1091 x 504 x 597 mm
Isolation Material	Cyclopentane	Net Weight	341 lbs / 155 kg
Cooling System	Ventilated	Gross Weight	427.7 lbs / 194 kg

## OMCAN INC.

Telephone: 1-800-465-0234

Fax: (905) 607-0234

Email: sales@omcan.com

Website: www.omcan.com

Follow us to keep up to date with the latest news and offers





SERVING THE FOOD INDUSTRY SINCE 1951

# AURORA 49" COOLER BACK BAR WITH 318L CAPACITY SOLID DOORS

Item: 59057 Model: BB-CN-0012E-SH



## MAIN FEATURES

- ▶ Durable and spacious
- ▶ High quality stainless steel 304
- ▶ CFC free refrigerant and foam
- ▶ Digital temperature controller and LCD display (Carel)
- ▶ Ventilated, automatic defrosting and evaporation of condensation water
- ▶ Adjustable heavy-duty PVC coated shelves
- ▶ Round interior corners for easy cleaning
- ▶ Self-closing doors fitted and durable door lock
- ▶ Castor with brake

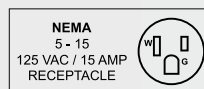

Authorized Dealer



# AURORA COOLER BACK BAR 49" 318L SOLID DOORS



## TECHNICAL DRAWINGS & DIMENSIONS

\*measurements in diagrams are in mm

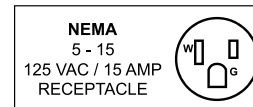
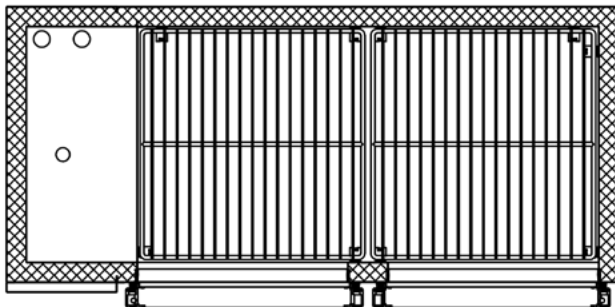
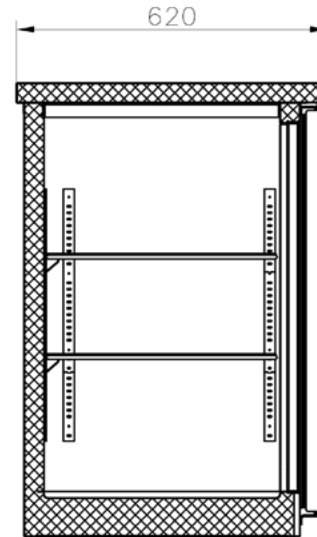
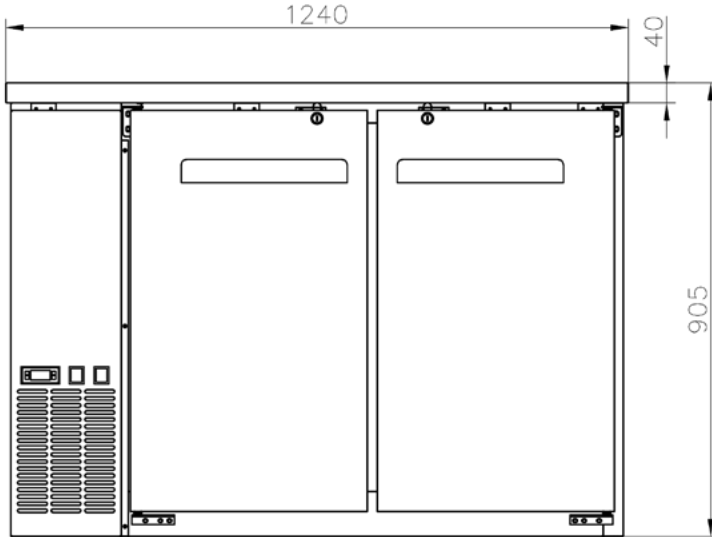

This equipment is intended for indoor environment using where ambient temperature do not exceed **24°C/ 75°F** & **55%** relative humidity

### 49" Aurora Cooler Back Bar With 11.2 cu.ft / 318 L Capacity Solid Doors

Item Number	59057	Defrosting	Automatic
Model	BB-CN-0012E-SH	Number of Door	2
Net volume	11.2 cu. ft / 318 L	Self-closing Door	YES
Temperature Range	33°F - 40°F / 0.5°C - 4.4°C	Number of Shelves	4
Refrigerant	R290	Shelf Material	Plastic Coated
Electrical	110V / 60Hz / 1Ph	Shelf Loading Capacity	88 lbs / 40 kg
Power	346 W	Exterior Dimensions (WDH)	48.8" x 24.4" x 35.6" / 1240 x 620 x 905 mm
Current	3.7 A	Interior Dimensions (WDH)	36.2" x 18.5" x 30.5" / 920 x 470 x 775 mm
Isolation Material	Cyclopentane	Net Weight	105 kg / 231.5 lbs
Cooling System	Ventilated	Gross Weight	128 kg / 282.2 lbs

## OMCAN INC.

Telephone: 1-800-465-0234

Fax: (905) 607-0234

Email: sales@omcan.com

Website: www.omcan.com

Follow us to keep up to date with the latest news and offers





SERVING THE FOOD INDUSTRY SINCE 1951

# AURORA 73" COOLER BACK BAR WITH 525L CAPACITY SOLID DOORS

Item: 59061 Model: BB-CN-0020E-SH



## MAIN FEATURES

- ▶ Durable and spacious
- ▶ High quality stainless steel 304
- ▶ CFC free refrigerant and foam
- ▶ Digital temperature controller and LCD display (Carel)
- ▶ Ventilated, automatic defrosting and evaporation of condensation water
- ▶ Adjustable heavy-duty PVC coated shelves
- ▶ Round interior corners for easy cleaning
- ▶ Self-closing doors fitted and durable door lock
- ▶ Castor with brake

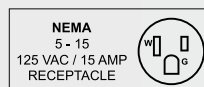

Authorized Dealer

# AURORA COOLER BACK BAR 73" 525L SOLID DOORS



## TECHNICAL DRAWINGS & DIMENSIONS

\*measurements in diagrams are in mm

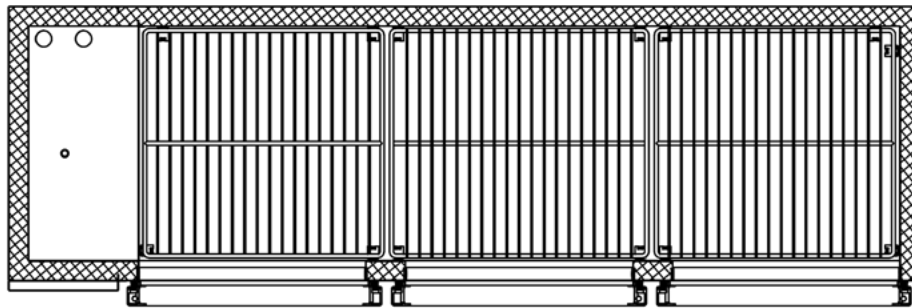
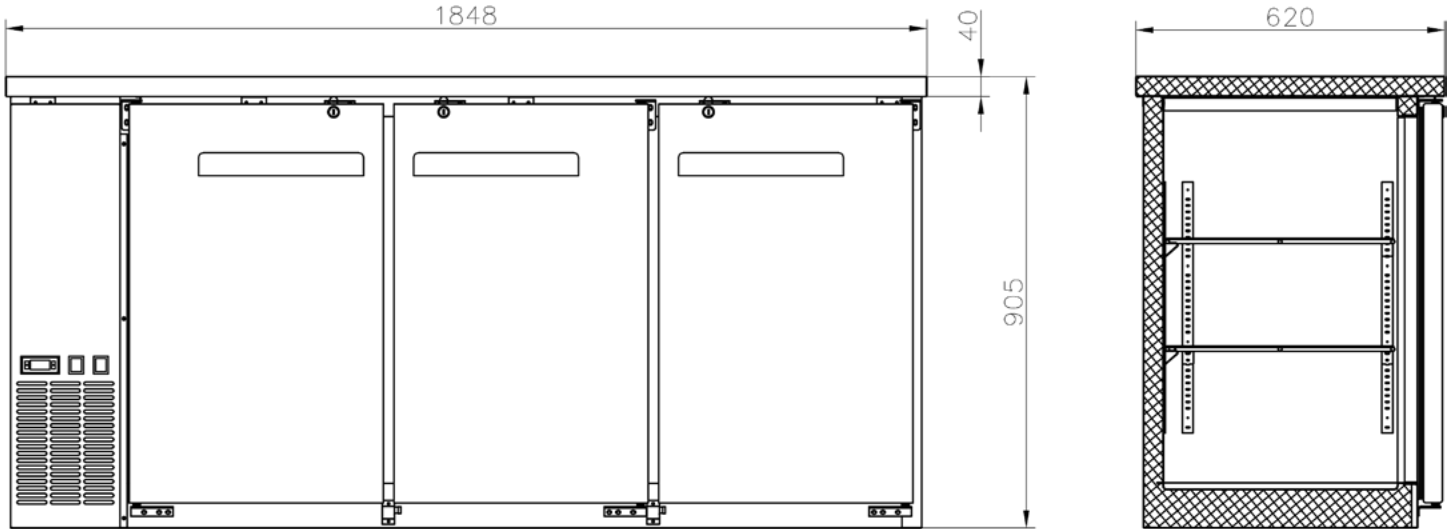

NEMA  
5 - 15  
125 VAC / 15 AMP  
RECEPTACLE



Intertek



Intertek

This equipment is intended for indoor environment using where

ambient temperature  
do not exceed **24°C / 75°F**  
& **55%** relative humidity

### 73" Aurora Cooler Back Bar With 18.5 Cu.ft / 525 L Capacity Solid Doors

Item Number	59061	Defrosting	Automatic
Model	BB-CN-0020E-SH	Number of Door	3
Net volume	18.5 cu. ft / 525 L	Self-closing Door	YES
Temperature Range	33°F - 40°F / 0.5°C - 4.4°C	Number of Shelves	6
Refrigerant	R290	Shelf Material	Plastic Coated
Electrical	110V / 60Hz / 1Ph	Shelf Loading Capacity	88 lbs / 40 kg
Power	396 W	Exterior Dimensions (WDH)	72.8" x 24.4" x 35.6" / 1848 x 620 x 905 mm
Current	4.1 A	Interior Dimensions (WDH)	60.2" x 18.5" x 30.5" / 1528 x 470 x 775 mm
Isolation Material	Cyclopentane	Net Weight	150 kg / 330.7 lbs
Cooling System	Ventilated	Gross Weight	170 kg / 374.8 lbs

## OMCAN INC.

Telephone: 1-800-465-0234

Fax: (905) 607-0234

Email: sales@omcan.com

Website: www.omcan.com

Follow us to keep up to date with the latest news and offers







SERVING THE FOOD INDUSTRY SINCE 1951

# AURORA 49" COOLER BACK BAR WITH 318L CAPACITY GLASS DOORS

Item: 59058 Model: BB-CN-0012E-GH



## MAIN FEATURES

- ▶ Durable and spacious
- ▶ High quality stainless steel 304
- ▶ CFC free refrigerant and foam
- ▶ Digital temperature controller and LCD display (Carel)
- ▶ Ventilated, automatic defrosting and evaporation of condensation water
- ▶ Adjustable heavy-duty PVC coated shelves
- ▶ Round interior corners for easy cleaning
- ▶ Self-closing doors fitted and durable door lock
- ▶ Castor with brake

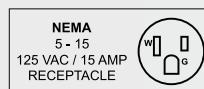

Authorized Dealer

# AURORA COOLER BACK BAR 49" 318L GLASS DOOR



## TECHNICAL DRAWINGS & DIMENSIONS

\*measurements in diagrams are in mm

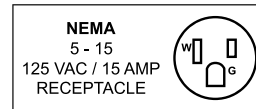
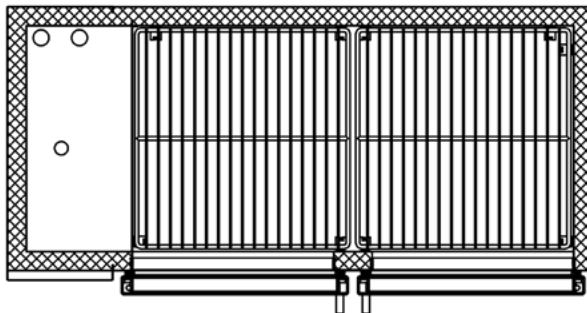
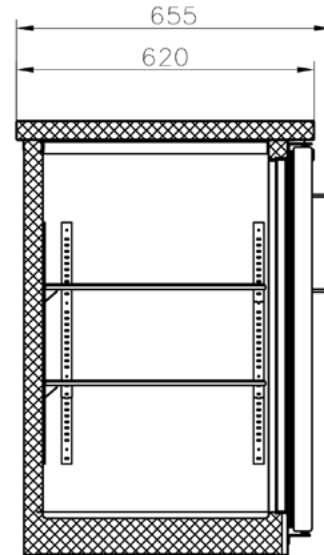
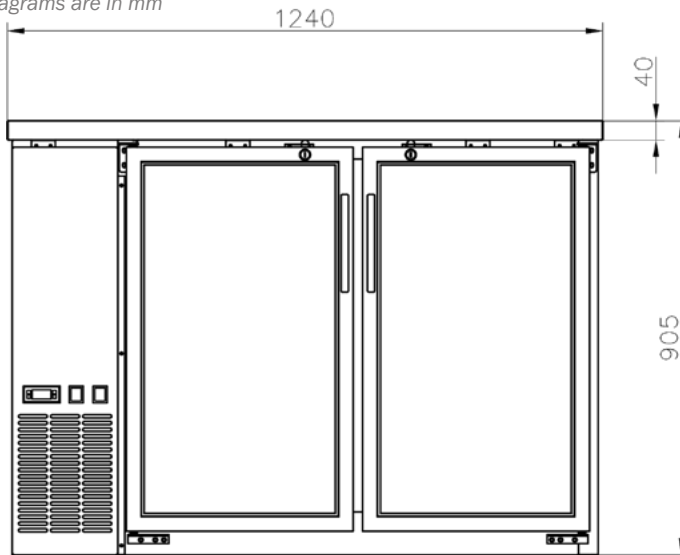

This equipment is intended for indoor environment using where

ambient temperature do not exceed **24°C / 75°F** & **55%** relative humidity

### 49" Aurora Cooler Back Bar With 11.2 cu.ft / 318 L Capacity Glass Doors

Item Number	59058	Defrosting	Automatic
Model	BB-CN-0012E-GH	Number of Door	2
Net volume	11.2 cu. ft / 318 L	Self-closing Door	YES
Temperature Range	33°F - 40°F / 0.5°C - 4.4°C	Number of Shelves	4
Refrigerant	R290	Shelf Material	Plastic Coated
Electrical	115V / 60Hz / 1Ph	Shelf Loading Capacity	88 lbs / 40 kg
Power	273 W	Exterior Dimensions (WDH)	48.8" x 24.4" x 35.6" / 1240 x 620 x 905 mm
Current	2.88 A	Interior Dimensions (WDH)	36.2" x 18.5" x 30.5" / 920 x 470 x 775 mm
Isolation Material	Cyclopentane	Net Weight	105 kg / 231.5 lbs
Cooling System	Ventilated	Gross Weight	128 kg / 282.2 lbs

## OMCAN INC.

Telephone: 1-800-465-0234

Fax: (905) 607-0234

Email: sales@omcan.com

Website: www.omcan.com

Follow us to keep up to date with the latest news and offers





SERVING THE FOOD INDUSTRY SINCE 1951

## AURORA 26-INCH DISPLAY REFRIGERATOR WITH SINGLE-DOOR GLASS

Item: 59035 Model: RE-CN-0014E-H



### MAIN FEATURES

- ▶ Large capacity can display a variety of food and beverages for customers
- ▶ Stainless steel interior and exterior, aluminum back
- ▶ CFC free refrigerant and foam
- ▶ Digital temperature controller and LCD display (Carel)
- ▶ Ventilated, automatic defrosting and evaporation of condensation water
- ▶ Adjustable heavy-duty PVC coated shelves
- ▶ Self-closing doors with 90 degree stay-open feature
- ▶ Uses Hydro-Carbon R290 refrigerant which is environmentally friendly and more efficient

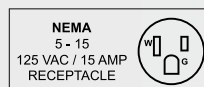

Authorized Dealer

# AURORA REFRIGERATOR 26" 382L SINGLE-DOOR GLASS



## TECHNICAL DRAWINGS & DIMENSIONS

\*measurements in diagrams are in mm

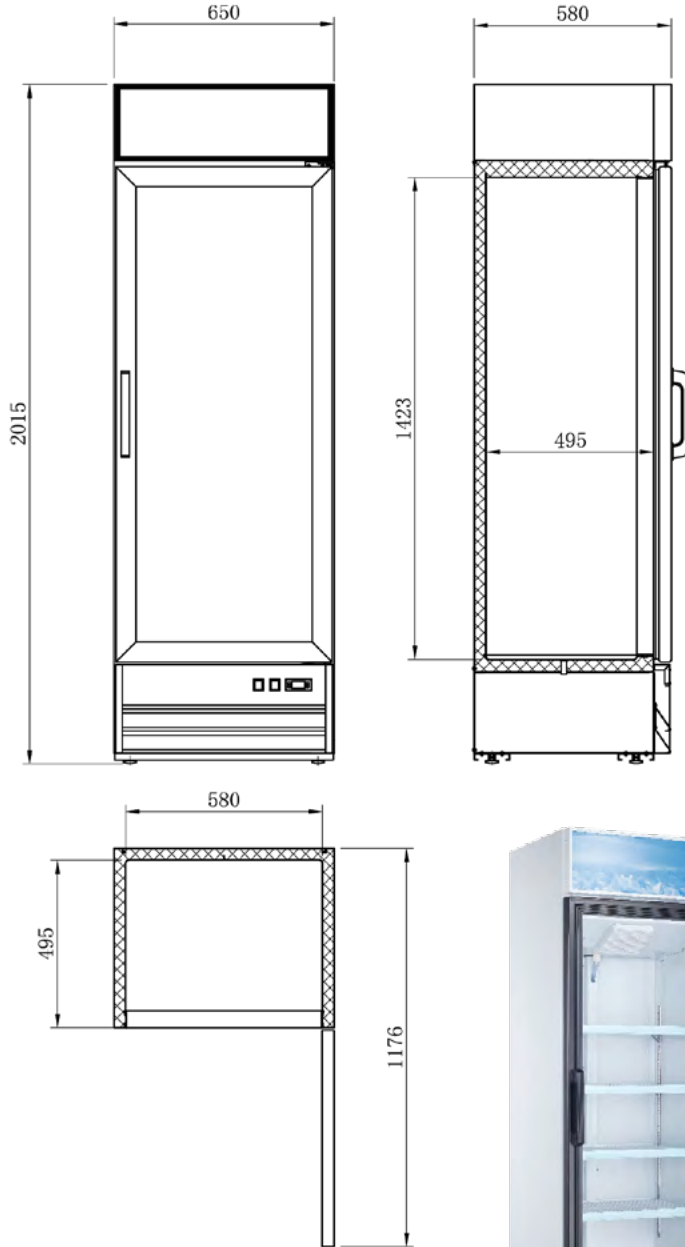

## TECHNICAL SPECIFICATIONS

26" Aurora Display Refrigerator With Single-Door Glass 382 L	
Item Number	59035
Model	RE-CN-0014E-H
Capacity	13.5 cu. ft / 382 L
Temperature Range	33°F - 40°F / 0.5°C - 4.4°C
Refrigerant	R290
Electrical	110V / 60Hz / 1Ph
Power	288 W
Current	3.0 A
Isolation Material	Cyclopentane
Cooling System	Ventilated
Defrosting	Automatic
Number of Door	1
Self-closing Door	YES
Number of Shelves	4
Shelf Material	Plastic Coated
Shelf Loading Capacity (Per PC)	88 lbs / 40 kg
Exterior Dimensions (WDH)	25.6" x 22.8" x 79.3" 650 x 580 x 2015 mm
Interior Dimensions (WDH)	22.8" x 19.5" x 55.5" 580 x 495 x 1410 mm
Net Weight	120 kg / 264.6 lbs
Gross Weight	135 kg / 297.6 lbs

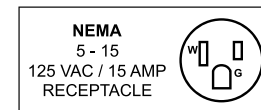

This equipment is intended for indoor environment using where

ambient temperature  
do not exceed 24°C / 75°F  
& 55% relative humidity

## OMCAN INC.

Telephone: 1-800-465-0234

Fax: (905) 607-0234

Email: sales@omcan.com

Website: www.omcan.com

Follow us to keep up to date with the latest news and offers





SERVING THE FOOD INDUSTRY SINCE 1951

# AURORA 29-INCH DISPLAY REFRIGERATOR WITH SINGLE-DOOR GLASS

Item: 59036 Model: RE-CN-0023E-HC



## MAIN FEATURES

- ▶ Large capacity can display a variety of food and beverages for customers
- ▶ Stainless steel interior and exterior, aluminum back
- ▶ CFC free refrigerant and foam
- ▶ Digital temperature controller and LCD display (Carel)
- ▶ Ventilated, automatic defrosting and evaporation of condensation water
- ▶ Adjustable heavy-duty PVC coated shelves
- ▶ Self-closing doors with 90 degree stay-open feature
- ▶ Uses Hydro-Carbon R290 refrigerant which is environmentally friendly and more efficient

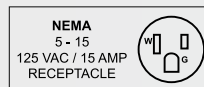

Authorized Dealer



# AURORA REFRIGERATOR 29" 640L SINGLE-DOOR GLASS



## TECHNICAL DRAWINGS & DIMENSIONS

\*measurements in diagrams are in mm

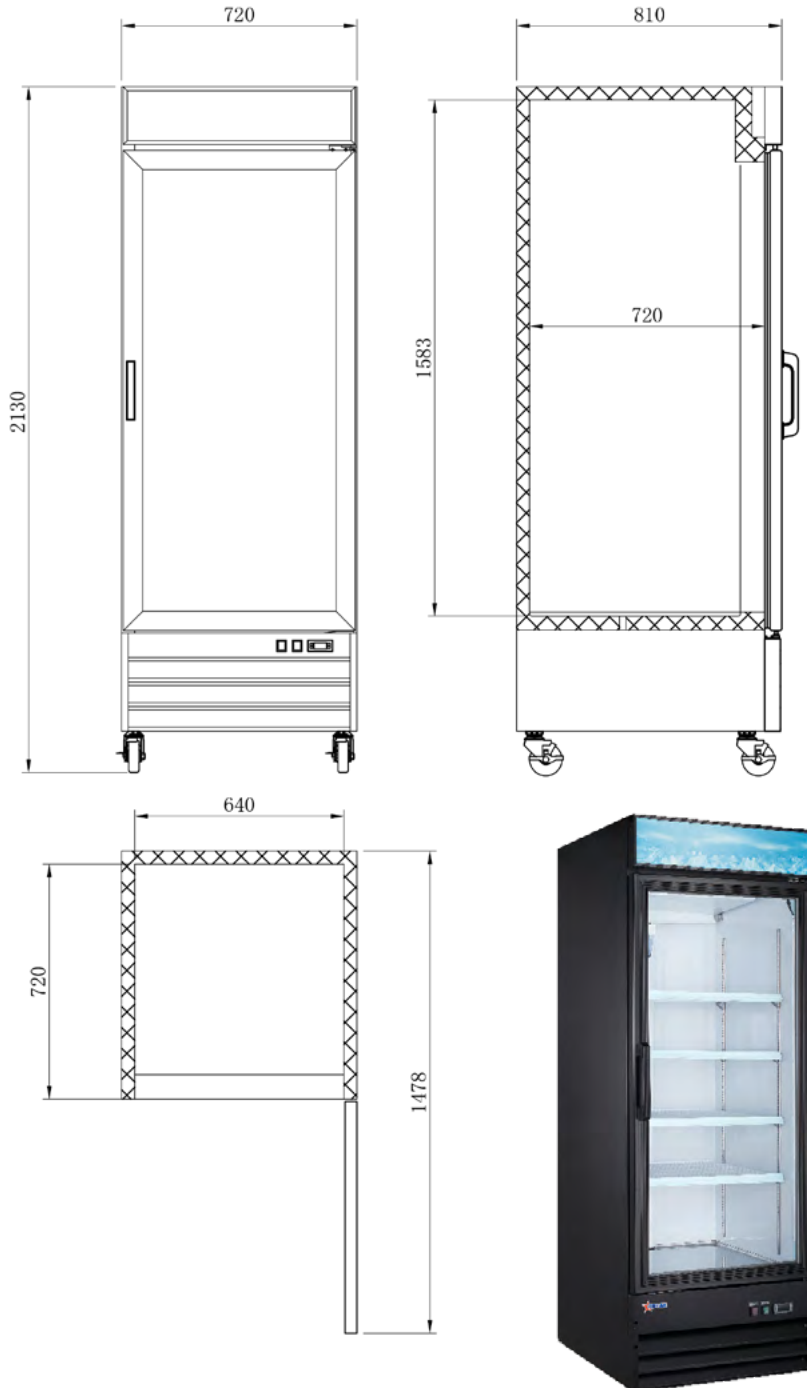

## TECHNICAL SPECIFICATIONS

29" Aurora Display Refrigerator With Single-Door Glass 640 L	
Item Number	59036
Model	RE-CN-0023E-HC
Capacity	22.6 cu. ft / 640 L
Temperature Range	33°F - 40°F / 0.5°C - 4.4°C
Refrigerant	R290
Electrical	110V / 60Hz / 1Ph
Power	384 W
Current	3.96 A
Isolation Material	Cyclopentane
Cooling System	Ventilated
Defrosting	Automatic
Number of Door	1
Self-closing Door	YES
Number of Shelves	4
Shelf Material	Plastic Coated
Shelf Loading Capacity (Per PC)	88 lbs / 40 kg
Exterior Dimensions (WDH)	28.3" x 31.9" x 79.3" 720 x 810 x 2015 mm
Interior Dimensions (WDH)	25.2" x 28.3" x 62.5" 640 x 720 x 1588 mm
Net Weight	145 kg / 319.7 lbs
Gross Weight	160 kg / 352.7 lbs

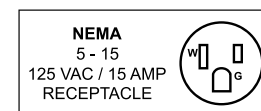

This equipment is intended for indoor environment using where

ambient temperature  
do not exceed 24°C / 75°F  
& 55% relative humidity

## OMCAN INC.

Telephone: 1-800-465-0234

Fax: (905) 607-0234

Email: sales@omcan.com

Website: www.omcan.com

Follow us to keep up to date with the latest news and offers

